

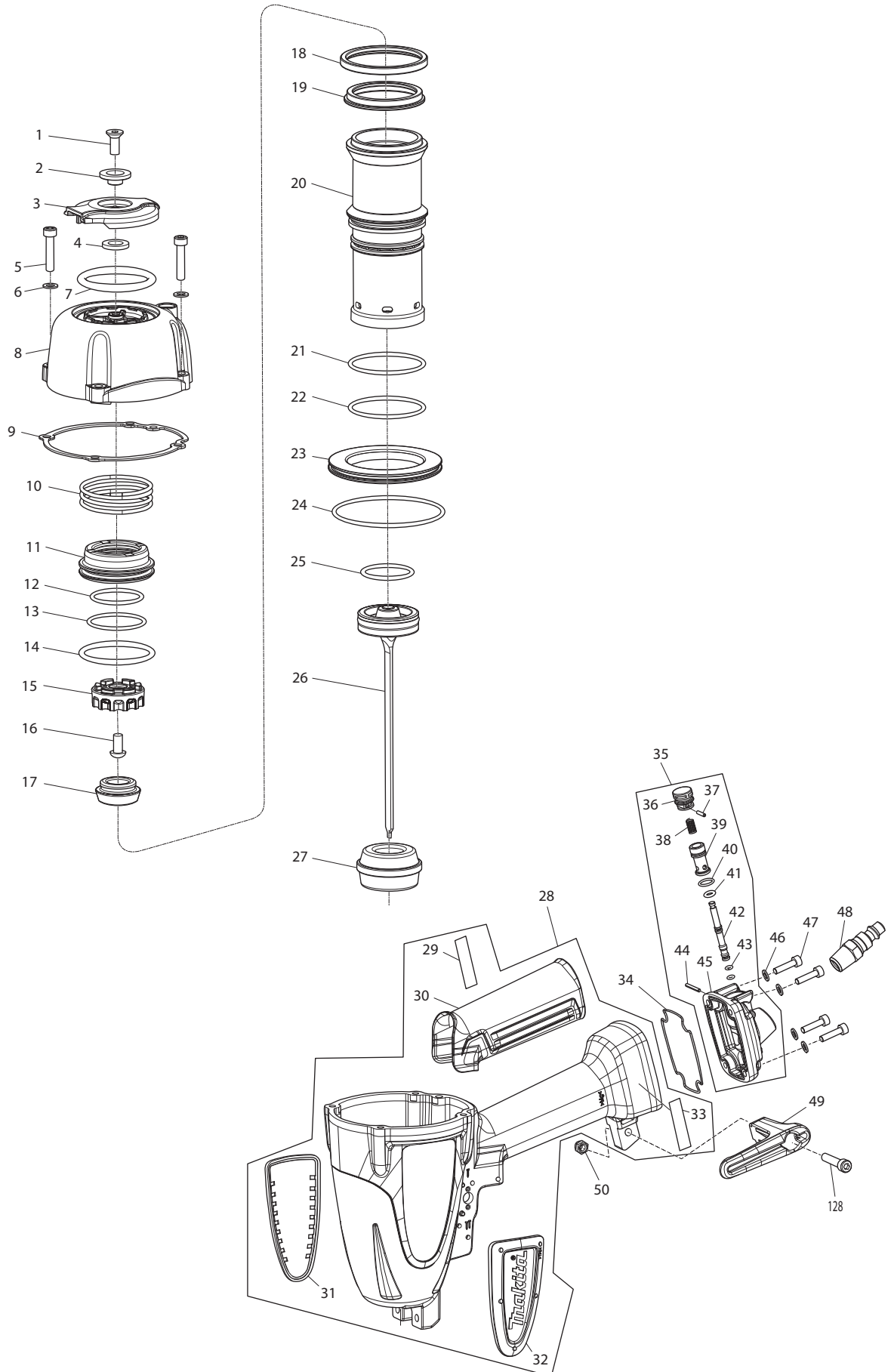

10 - 2016

AF635

2-1/2" Finishing Nailer 15 Ga.



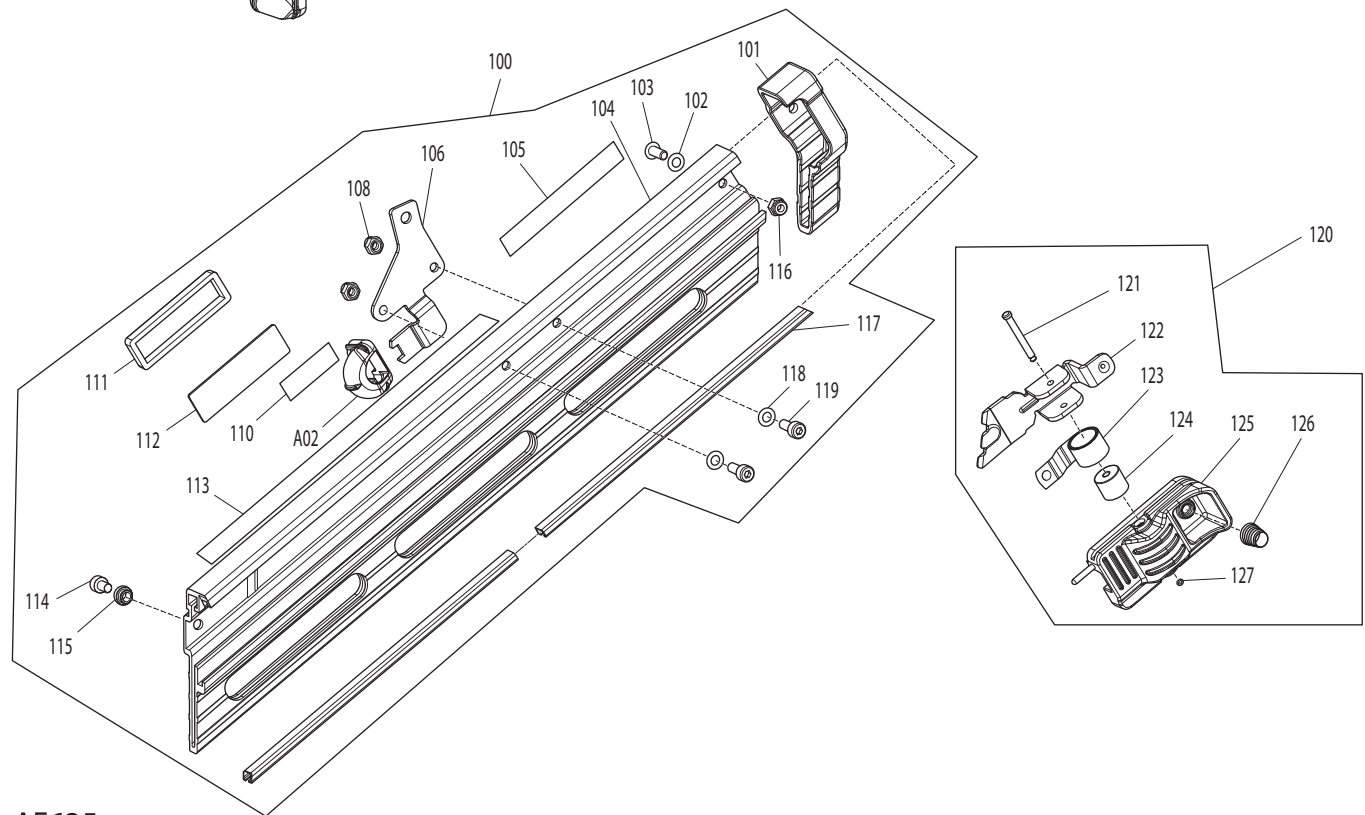
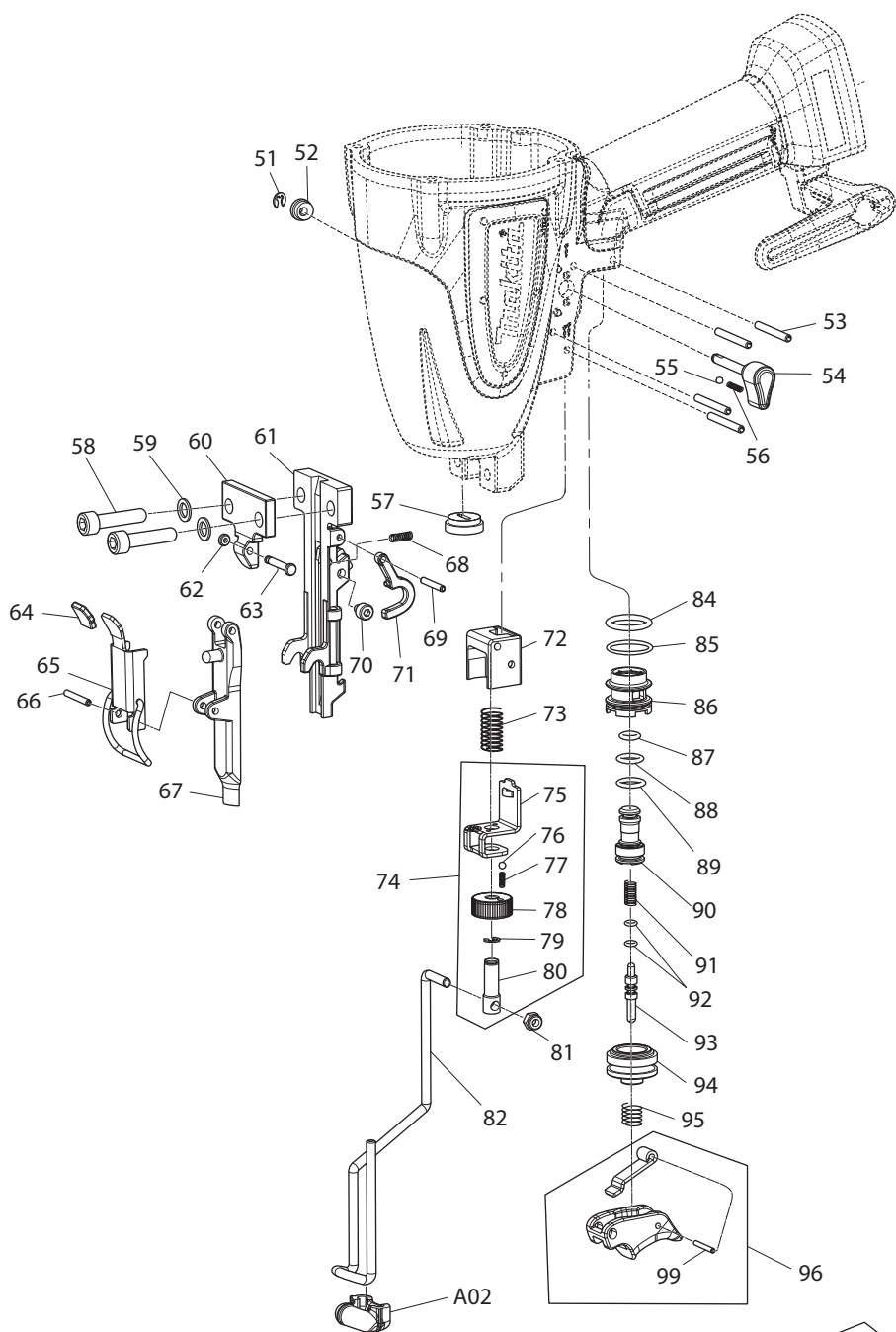

Item Type	Part No	Description	Qty	Unit
001	HY00000655	HEX SOCKET C.S.HEAD SCREW M6X20	1	PC.
002	HY00000522	SLEEVE 6	1	PC.
003	HY00000454	EXHAUST COVER	1	PC.
004	HY00000627	RUBBER RING 10	1	PC.
005	HY00000075	HEX SOCKET HEAD BOLT M5X30	4	PC.
006	HY00000160	FLAT WASHER 5	4	PC.
007	HY00000523	FILTER	1	PC.
008	HY00000450	TOP CAP	1	PC.
009	HY00000449	TOP CAP GASKET	1	PC.
010	HY00000456	COMPRESSION SPRING 44	1	PC.
011	HY00000453	HEAD VALVE	1	PC.
012	HY00000409	O RING 30.5	1	PC.
013	HY00000020	O RING 36	1	PC.
014	HY00000141	O RING 45	1	PC.
015	HY00000455	HEAD VALVE GUIDE	1	PC.
016	HY00000677	HEX SOCKET BUTTON HEAD SCREW M6X12	1	PC.
017	HY00000517	REAR CUSHION	1	PC.
018	HY00000451	VALVE SHEET GUIDE	1	PC.
019	HY00000452	VALVE SHEET	1	PC.
020	HY00000601	CYLINDER	1	PC.
021	HY00000405	O RING 48	1	PC.
022	HY00000402	O RING 44	1	PC.
023	HY00000448	CYLINDER SEPARATER	1	PC.
024	HY00000412	O RING 72	1	PC.
025	HY00000139	O RING 35	1	PC.
026	HY00000550	DRIVER COMPLETE	1	PC.
027	HY00000457	FRONT CUSHION	1	PC.
028	HY00000641	HOUSING COMPLETE	1	PC.
	INC.	Item No. 29-33		
029	HY00000587	NAME PLATE F/635	1	PC.
030	HY00000557	GRIP	1	PC.
031	HY00000427	HOUSING BUMPER, R	1	PC.
032	HY00000426	HOUSING BUMPER, L	1	PC.
033	HY00000105	CAUTION LABEL	1	PC.
034	HY00000580	SEAL RING	1	PC.
035	HY00000495	BLOWER COMPLETE	1	PC.
	INC.	Item No. 36-45		
036	HY00000573	DUSTER BUTTON	1	PC.
037	HY00000046	PIN 2	1	PC.
038	HY00000591	COMPRESSION SPRING 5	1	PC.
039	HY00000599	VALVE GUIDE	1	PC.
040	HY00000399	O RING 8.5	1	PC.
041	HY00000397	O RING 5	1	PC.
042	HY00000513	VALVE STEM	1	PC.
043	HY00000037	O RING 3	2	PC.
044	HY00000054	SPRING PIN 2.5-18	1	PC.
045	HY00000498	INLET CAP	1	PC.
046	HY00000070	FLAT WASHER 4	4	PC.
047	HY00000530	HEX SOCKET HEAD BOLT M4X20	4	PC.
048	HY00000079	ONE TOUCH JOINT	1	PC.
049	HY00000569	HOOK	1	PC.
050	HY00000528	HEX LOCK NUT M5	1	PC.
051	HY00000659	STOP RING E-3	2	PC.

Item Type	Part No	Description	Qty	Unit
052	HY00000520	SLEEVE 4	1	PC.
053	HY00000165	SPRING PIN 3-28	4	PC.
054	HY00000518	LEVER 4	1	PC.
055	HY00000526	STEEL BALL 3	1	PC.
056	HY00000590	COMPRESSION SPRING 2	1	PC.
057	HY00000023	FRONT SEAL	1	PC.
058	HY00000652	HEX SOCKET HEAD BOLT M6X30	2	PC.
059	HY00000163	SPRING WASHER 6	2	PC.
060	HY00000464	PLATE	1	PC.
061	HY00000605	DRIVER GUIDE	1	PC.
062	HY00000043	RUBBER RING 2	1	PC.
063	HY00000461	PIN 3	1	PC.
064	HY00000051	CAP	1	PC.
065	HY00000462	LATCH	1	PC.
066	HY00000678	ROLL PIN 3-20	1	PC.
067	HY00000463	DOOR	1	PC.
068	HY00000469	COMPRESSION SPRING 3	1	PC.
069	HY00000658	SPRING PIN 2.5-12	1	PC.
070	HY00000649	HEX SOCKET HEAD BOLT M4X4	1	PC.
071	HY00000467	STOPPER	1	PC.
072	HY00000505	HOLDER	1	PC.
073	HY00000607	COMPRESSIONSPRING 8	1	PC.
074	HY00000440	UPPER YOKE COMPLETE	1	PC.
	INC.	Item No. 75-80		
075	HY00000443	UPPER YOKE	1	PC.
076	HY00000526	STEEL BALL 3	1	PC.
077	HY00000470	COMPRESSION SPRING 2	1	PC.
078	HY00000608	ADJUSTER DIAL	1	PC.
079	HY00000659	STOP RING E-3	1	PC.
080	HY00000609	ADJUSTER SHAFT	1	PC.
081	HY00000159	HEX LOCK NUT M4	1	PC.
082	HY00000442	CONTACT ARM	1	PC.
084	HY00000135	O RING 15	1	PC.
085	HY00000137	O RING 17	1	PC.
086	HY00000446	TRIGGER VALVE GUIDE	1	PC.
087	HY00000131	O RING 6	1	PC.
088	HY00000132	O RING 7	1	PC.
089	HY00000134	O RING 9	1	PC.
090	HY00000182	PILOT VALVE	1	PC.
091	HY00000146	COMPRESSION SPRING 4	1	PC.
092	HY00000037	O RING 3	2	PC.
093	HY00000514	TRIGGER VALVE STEM	1	PC.
094	HY00000447	TRIGGER VALVE CASE	1	PC.
095 2	HY00000705	COMPRESSION SPRING 10	1	PC.
096	HY00000433	TRIGGER COMPLETE	1	PC.
	INC.	Item No. 99		
099	HY00000042	SPRING PIN 2.5-17	1	PC.
100	HY00000471	MAGAZINE COMPLETE	1	PC.
	INC.	Item No. 101-106,108, 110-119, A02 (1PC.)		
101	HY00000466	MAGAZINE CAP	1	PC.
102	HY00000070	FLAT WASHER 4	1	PC.
103	HY00000654	BOTTOM BOLT M4X10	1	PC.
104	HY00000481	MAGAZINE	1	PC.

Item Type	Part No	Description	Qty	Unit
105	HY00000584	CAUTIONLABEL	1	PC.
106	HY00000541	JOINT	1	PC.
108	HY00000159	HEX LOCK NUT M4	2	PC.
110	HY00000582	CAUTIONLABEL	1	PC.
111	HY00000574	CASE	1	PC.
112	HY00000576	DOUBLE SIDED TAPE	1	PC.
113	HY00000583	CAUTION LABEL	1	PC.
114	HY00000074	HEX SOCKET HEAD BOLT M4X8	1	PC.
115	HY00000633	BUSH	1	PC.
116	HY00000159	HEX LOCK NUT M4	1	PC.
117	HY00000458	MAGAZINE RAIL	2	PC.
118	HY00000070	FLAT WASHER 4	2	PC.
119	HY00000001	HEX SOCKET HEAD BOLT M4X10	2	PC.
120	HY00000487	PUSHER BASE COMPLETE	1	PC.
	INC.	Item No. 121-127		
121	HY00000637	PIN 3	1	PC.
122	HY00000468	PUSHER	1	PC.
123	HY00000460	SPIRAL SPRING	1	PC.
124	HY00000459	SPRING HOLDER	1	PC.
125	HY00000465	PUSHER LEVER	1	PC.
126	HY00000630	CONICAL COMPRESSION SPRING 5-10	1	PC.
127	HY00000411	O RING 2	1	PC.
128	HY00000075	HEX SOCKET HEAD BOLT M5X30	1	PC.
C01	HY00000688	COLOR SLEEVE	1	PC.
C02	HY00000690	MASTER CARTON	1	PC.
<u>ACCESSORIES</u> - See Catalogue or visit www.makita.ca for more accessories -				
A01	HY00000686	PLASTIC CARRYING CASE (BLOW)	1	PC.
A02	HY00000422	NOSE ADAPTER	2	PC.
A04	-----	SAFETY GOGGLES	1	PC.
A05	181434-7	OIL SUPPLY 30CC	1	PC.
A06	-----	PNEUMATIC AIR HOSE		
A07	-----	HIGH PRESSURE PNEUMATIC HOSES		
A08	-----	PNEUMATIC HOSE FITTINGS		